

Reference

Tektronix

**2714 & 2715
Spectrum Analyzer
070-8535-06**

This document supports
Firmware Version 2.14.97 and
above.

Copyright © Tektronix, Inc. All rights reserved.

Tektronix products are covered by U.S. and foreign patents, issued and pending. Information in this publication supercedes that in all previously published material. Specifications and price change privileges reserved.

Tektronix, Inc., P.O. Box 1000, Wilsonville, OR
97070-1000

TEKTRONIX and TEK are registered trademarks of
Tektronix, Inc.

WARRANTY

Tektronix warrants that this product will be free from defects in materials and workmanship for a period of one (1) year from the date of shipment. If any such product proves defective during this warranty period, Tektronix, at its option, either will repair the defective product without charge for parts and labor, or will provide a replacement in exchange for the defective product.

In order to obtain service under this warranty, Customer must notify Tektronix of the defect before the expiration of the warranty period and make suitable arrangements for the performance of service. Customer shall be responsible for packaging and shipping the defective product to the service center designated by Tektronix, with shipping charges prepaid. Tektronix shall pay for the return of the product to Customer if the shipment is to a location within the country in which the Tektronix service center is located. Customer shall be responsible for paying all shipping charges, duties, taxes, and any other charges for products returned to any other locations.

This warranty shall not apply to any defect, failure or damage caused by improper use or improper or inadequate maintenance and care. Tektronix shall not be obligated to furnish service under this warranty a) to repair damage resulting from attempts by personnel other than Tektronix representatives to install, repair or service the product; b) to repair damage resulting from improper use or connection to incompatible equipment; or c) to service a product that has been modified or integrated with other products when the effect of such modification or integration increases the time or difficulty of servicing the product.

THIS WARRANTY IS GIVEN BY TEKTRONIX WITH RESPECT TO THIS PRODUCT IN LIEU OF ANY OTHER WARRANTIES, EXPRESSED OR IMPLIED. TEKTRONIX AND ITS VENDORS DISCLAIM ANY IMPLIED WARRANTIES OF MERCHANTABILITY OR FITNESS FOR A PARTICULAR PURPOSE. TEKTRONIX' RESPONSIBILITY TO REPAIR OR REPLACE DEFECTIVE PRODUCTS IS THE SOLE AND EXCLUSIVE REMEDY PROVIDED TO THE CUSTOMER FOR BREACH OF THIS WARRANTY. TEKTRONIX AND ITS VENDORS WILL NOT BE LIABLE FOR ANY INDIRECT, SPECIAL, INCIDENTAL, OR CONSEQUENTIAL DAMAGES IRRESPECTIVE OF WHETHER TEKTRONIX OR THE VENDOR HAS ADVANCE NOTICE OF THE POSSIBILITY OF SUCH DAMAGES.

Table of Contents

Controls and Menu Reference	2
Frequency/Markers Controls	4
Fundamental Controls	6
Numeric Keypad	8
Vertical Scale, Demodulator, and Display Controls	10
Display Storage Controls	12
Resolution BW and Sweep Controls	14
Menus	
TRIGGER Menu	16
SWEEP Menu	16
UTIL Menu	17
MKR/FREQ Menu	17
CATV Menu (2714 Only)	19
CATV Menu (2715 Only)	29
APPL Menu	33
DEMOD Menu	33
DSPL Menu	34
USER DEF Menu	35
INPUT Menu	35
Control Ranges	36

Controls and Menus Reference

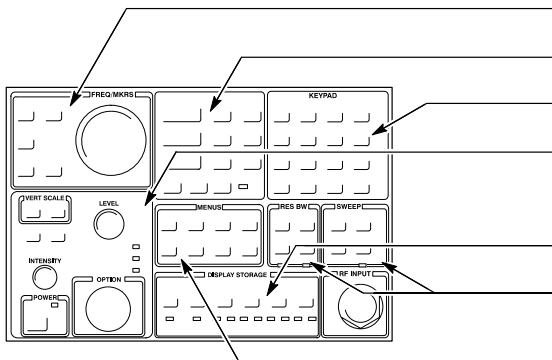

Frequency/Markers Controls	Page 4
Fundamental Controls	Page 6
Numeric Keypad	Page 8
Vertical Scale, Demodulator, and Display Controls	Page 10
Display Storage Controls	Page 12
Resolution BW and Sweep Controls	Page 14
Menus	
TRIGGER Menu	Page 16
SWEEP Menu	Page 16
UTIL Menu	Page 17
MKR/FREQ Menu	Page 18
CATV Menu	Page 19
APPL Menu	Page 33
DEMOD Menu	Page 33
DSPL Menu	Page 34
USER DEF Menu	Page 35
INPUT Menu	Page 35
Control Ranges	Page 36

Frequency/Markers Controls

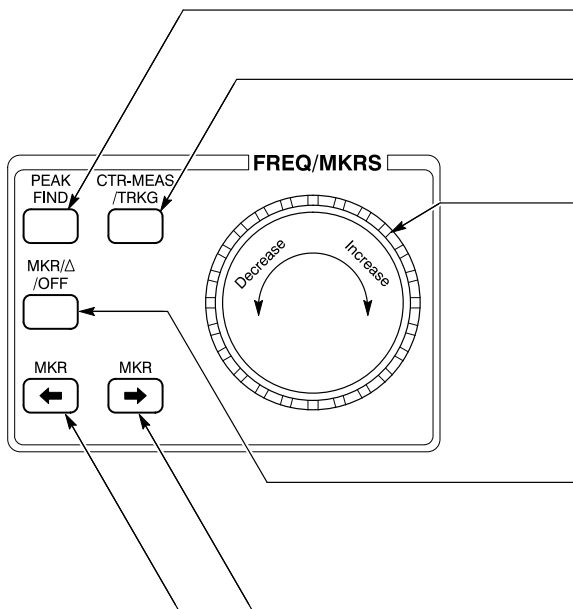

Moves marker to highest on-screen signal.

Press once for center measure (counts signal).
Press twice for signal track mode.
Press again for tracking off.

Depending upon mode, FREQ/MKRS knob changes:

- Center or start frequency
- Marker position
- Video line number for triggering

Knob also selects letters for titles and labels.

Press once for single marker.
Press twice for delta markers.
Press again for markers off.

Moves markers left or right to next on-screen signal above threshold.

Fundamental Controls

Selects channel, frequency, span/div, or ref level for immediate entry. Enter value from keypad and end entry with terminator key [W], [X], [Y], or [Z].

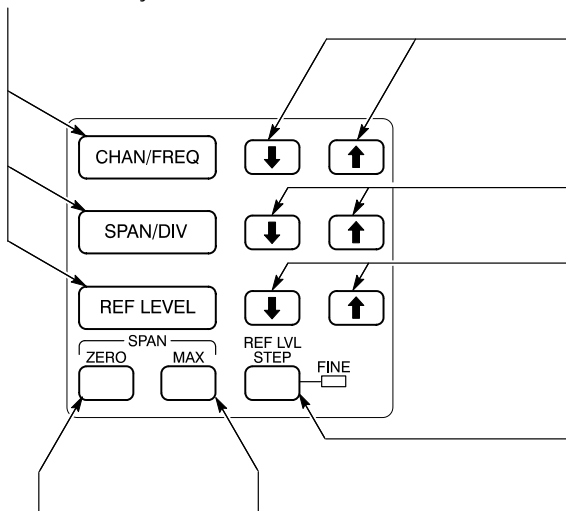

Press once for zero span mode (time domain); press again to restore previous span/div.

Press once for max span mode (180 MHz/div); press again to restore previous span/div.

Decrease (↓) or increase (↑) channel or frequency by one division in auto tuning mode or by the designated increment in other modes. ALWAYS ACTIVE.

Decrease (↓) or increase (↑) span/div in 1-2-5 sequence. ALWAYS ACTIVE.

Decrease (↓) or increase (↑) ref level in 1 dB or 10 dB steps. ALWAYS ACTIVE.

Toggle ref level step size between 1 dB (FINE LED on) and 10 dB (FINE LED off).

Choose REF LEVEL units: [INPUT][3][0-5]
(not available in CATV mode).

Select fixed RF Atten value in 2 dB increments
or select AUTO Atten: [INPUT][5].

Numeric Keypad

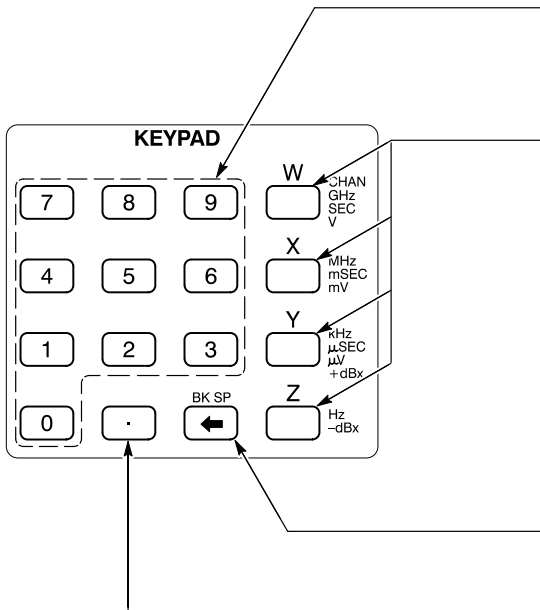

Dot Key:

- Decimal in numeric entries
- Period in text entries

Numeric Keys 0-9:

- Enter numeric values
- Make menu selections

Terminator Keys W, X, Y, Z:

- Signify end of entry
- Select required units

Backspace Key (BK SP):

- Back up one menu level
- Erase last character in data entry

Vertical Scale, Demodulator and Display Controls

Initiates screen plot.

Toggles vertical scale between LIN and LOG modes.

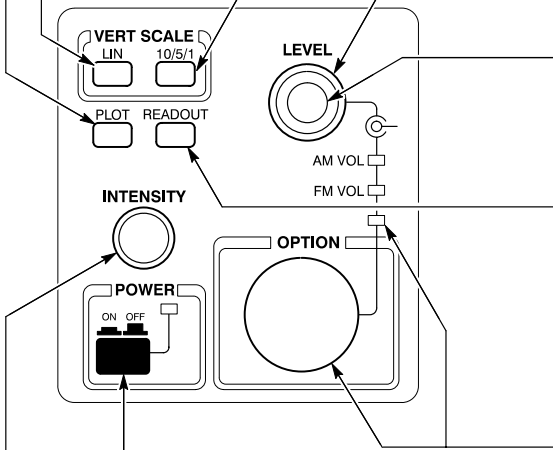

Varies CRT brightness.

Toggles power on (LED lighted) and off.

Press repeatedly to select LOG vertical scales in 10-5-1 dB sequence.

Controls volume of AM or FM demodulators.

Inner knob controls:

- Trigger level in Internal, Line and External modes
- Sweep position (manual scan mod)
- Picture framing (video monitor mode)

Toggles on-screen readouts on and off.

Option connector and indicator. LED is lighted when option is enabled.

Display Storage Controls

Activates MAX HOLD mode. In MAX HOLD mode the A & B registers (if active) retain the largest signals observed.

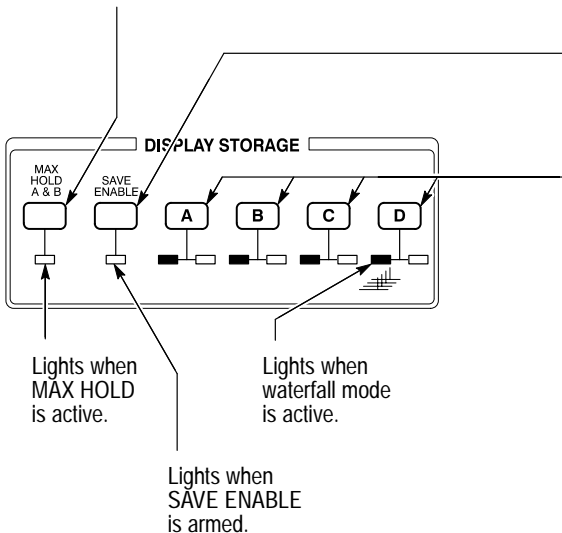

To enter waterfall mode:

- First clear the A, B, and C registers
- Press [SAVE ENABLE][D]

To exit, press [SAVE ENABLE][D].

Press to arm SAVE ENABLE, then press register A, B, or C to save or clear (unsave).

Toggles the indicated register (A, B, C, D) on or off, and saves (or clears) the display in the selected register when SAVE ENABLE is armed. Individual waveforms cannot be saved in the D register.

■ Green LEDs light when indicated register (A, B, or C) contains a saved waveform, whether displayed or not.

□ Red LEDs light when indicated register (A, B, C, D) is displaying a waveform.

Resolution BW and Sweep Controls

Decreases (↓) or increases (↑)
the RES BW filter bandwidth.

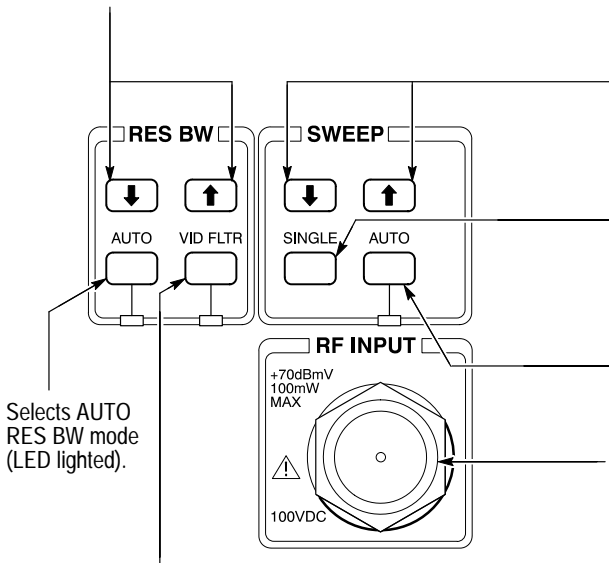

Decreases (↓) or increases (↑)
the sweep rate in 1-2-5 sequence.

Press once to select single sweep
mode. Press again to arm sweep.
Sweep begins after next trigger signal.

Selects AUTO sweep rate
mode (LED lighted).

RF input signal connector.
OBSERVE MAXIMUM INPUT RATINGS.

Select fixed or AUTO Video Filter value: [UTIL][2][5].

Cancel single sweep mode: [AUTO].

Select HORIZ TV Line triggering: [SWP/TRIG][9].

TRIGGER Menu

- 0 FREE RUN
- 1 INTERNAL
- 2 EXTERNAL
- 3 LINE
- 4 TV LINE
- 5 TV FIELD

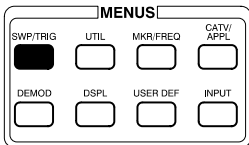

SWEEP Menu

- 6 SWEEP RATE
 - 7 MANUAL SCAN
 - 8 SYNC POLARITY
 - 9 SETUP TABLE
- Configures HORIZONTAL TV LINE Triggering
- 0 Continuous
 - 1 Knob selectable
 - 2 Keypad entered line
 - 3 Keypad entry
 - 4 TV line standard

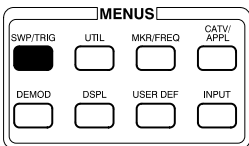

UTIL Menu

1 STORED SETTINGS

0 Last power-down

1 Factory default

power-up

2 User defined

power-up

3-39 Stored

setting/display registers

2 KEYPAD ENTERED SETTINGS

3 NORMALIZATIONS

4 SYSTEM CONFIGURATION

0, 1, 2 Comm port, screen plot, and
printer config (GPIB & RS-232 options only)

3 Instrument config

4 Real-time clock setup

5 Stored settings protect

6, 7 File system

9 Installed options

5 INST DIAGNOSTICS/ADJUSTMENTS

6 SERVICE REQUEST

9 MORE

0 Print readouts (RS-232 option only)

8 Edit channel table (shortcut)¹

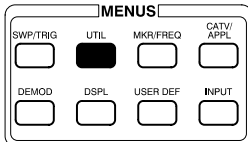

¹ Option 50 and Option 75 only

MKR/FREQ Menu

- 0 THRESHOLD
- 1 PROGRMD TUNING INC
 - 0 Center freq
 - 1 Marker freq
 - 2 Keypad entered inc
 - 3 Keypad entry
 - 4 Return to auto
- 2 KNOB FUNCTION
- 3 MARKER TO REFERENCE LEVEL
- 4 MOVE MARKER TO NEXT PEAK
- 5 TRANSPOSE MARKERS
- 6 MARKER START/STOP
- 7 FREQUENCY START/STOP
- 8 TUNING INCREMENT
 - Auto or progrmd
- 9 SETUP TABLE
 - 0 Center/start freq
 - 1 Counter resolution
 - 3 Freq offset
 - 4 Freq offset mode

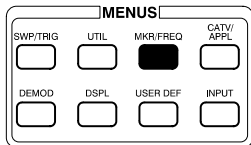

CATV Menu (2714 Only)

(Page 1)

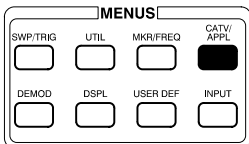

- 0 RECENTER CHANNEL xx¹
- 1 CARRIER LEVELS
 - 0 Run carrier levels
 - 1 Store current results
 - 2 Display results
 - 3 Print current results (RS-232 only)
 - 4 Print stored results (RS-232 only)
 - 5 Set up carrier levels
 - 0 Accurate frequency and ampl
 - 1 Accurate amplitude only
 - 2 Fast amplitude only
 - 6 External atten/amp
 - 0 On/off
 - 1 Atten/ampl entry
 - 9 Leave carrier levels
- 2 CARRIER SURVEY
 - 0 Run carrier survey
 - 1 Store current results
 - 2 Display results
 - 3 Print current results (RS-232 only)
 - 4 Print stored results (RS-232 only)
 - 5 Set up carrier survey
 - 0 Accurate frequency and ampl
 - 1 Accurate amplitude only
 - 2 Fast amplitude only
 - 6 External atten/amp
 - 0 On/off
 - 1 Atten/ampl entry
 - 9 Leave carrier survey

¹ Active Channel Number

CATV Menu (2714 Only) (Continued)

(Page 1 Continued)

- 3 MODULATION DEPTH
 - 0 Run modulation depth
 - 1 Store current results
 - 2 Display results
 - 3 Print current results
(RS-232 only)
 - 4 Print stored results (RS-232 only)
 - 5 Set up adjustment mode
 - 0 View modulation mode
 - 1 Target line
 - 2 Cycle delay
 - 3 Target line duration
 - 6 Enter adjustment mode
 - 9 Leave modulation depth
- 4 AURAL (FM) DEVIATION
 - 0 Run FM deviation
 - 1 Store current results
 - 2 Display results
 - 3 Print current results (RS-232 only)
 - 4 Print stored results (RS-232 only)
 - 5 Set up aural (FM) deviation
 - 0 Interactive
 - 1 Auto
 - 5 Measurement time
 - 6 Enter adjustment mode
 - 9 Leave aural (FM) deviation

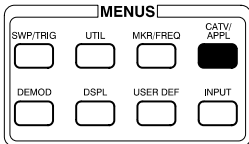

CATV Menu (2714 Only) (Continued)

(Page 1 Continued)

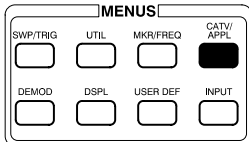

5 CARRIER TO NOISE

- 0 Run carrier/noise
- 1 Store current results
- 2 Display results
- 3 Print current results (RS-232 only)
- 4 Print stored results (RS-232 only)
- 5 Set up carrier/noise
 - 0 Interactive
 - 1 Auto
 - 2 Auto (Pause for carrier off)
 - 5 Noise norm'd BW
- 9 Leave carrier to noise

6 HUM/LFD

- 0 Run hum/LFD
- 1 Store current results
- 2 Display results
- 3 Print current results (RS-232 only)
- 4 Print stored results (RS-232 only)
- 5 Power line freq
- 9 Leave hum/LFD

7 FREQUENCY RESPONSE

- 0 Run freq resp
- 5 Set up freq resp
 - 0 No ref
 - 1 With ref
 - 2 Start frequency
 - 3 Stop frequency
 - 4 Use default start/stop
 - 5 Acquire new reference²
 - 6 Stored reference menu²
 - 7 Edit current reference name³
- 9 Leave frequency response

² Displayed only if WITH REF is selected

³ Displayed only if WITH REF is selected and a reference has been acquired

CATV Menu (2714 Only) (Continued)

(Page 1 Continued)

- 8 CATV MEASUREMENT SETUP
 - 0 Exit CATV measurement mode
 - 1 Channel table
 - 0 STD
 - 1 HRC
 - 2 IRC
 - 3-9 User defined tables
 - 2 Skip channel
 - 3 All channels
 - 4 Site
 - 5 Operator
 - 6 Ref level unit
 - 8 Remove all stored results
 - 9 Leave CATV measurements setup
- 9 MORE (Go to Page 2 of the CATV Menu)

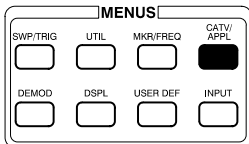

CATV Menu (2714 Only) (Continued)

(Page 2)

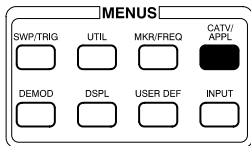

- 0 RECENTER CHANNEL xx⁴
- 1 VIEW MODULATION (FIELD)
- 2 VIEW MODULATION (LINE)
- 3 VIEW PICTURE
- 4 LISTEN
- 5 CTB
 - 0 Run CTB
 - 1 Store current results
 - 2 Display results
 - 3 Print current results (RS-232 only)
 - 4 Print stored results (RS-232 only)
 - 5 Set up CTB
 - 0 Interactive
 - 1 Auto
 - 2 Auto (pause for carrier off)
 - 3 Single sweep
 - 5 Set up Test Frequencies
 - 0-4 User-Defined Test Frequencies
 - 5 Use Default Test Frequencies
- 6 Digital/analog
- 9 Leave CTB

⁴ Active Channel Number

CATV Menu (2714 Only) (Continued)

(Page 2 Continued)

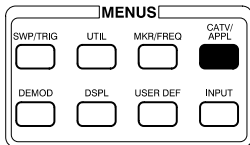

6 CSO

0 Run CSO

1 Store current results

2 Display results

3 Print current results

(RS-232 only)

4 Print stored results (RS-232 only)

5 Set up CSO

0 Interactive

1 Auto

2 Auto (Pause for carrier off)

3 Single sweep

4 Continuous

5 Set Up Test Frequencies⁵

0-4 User-Defined Test Frequencies

5 Use Default Test Frequencies

6 Carrier Frequency⁶

7 Test Interval⁶

8 Normalization Interval⁶

6 Digital/analog

9 Leave CSO

7 CROSS MODULATION

0 Run cross modulation

1 Store current results

2 Display results

3 Print current results (RS-232 only)

4 Print stored results (RS-232 only)

9 Leave cross modulation

⁵ Not displayed if in Interactive mode

⁶ Displayed only if in Continuous mode

CATV Menu (2714 Only) (Continued)

(Page 2 Continued)

8 IN-CHANNEL RESPONSE

- 0 Run in-chan resp
- 1 Store current results
- 2 Display results
- 3 Print current results
(RS-232 only)
- 4 Print stored results (RS-232 only)
- 5 Set up In-chan resp
 - 0 Interactive
 - 1 Auto (pause for signal on)
 - 2-7 user-defined test frequencies⁷
 - 8 Use default test frequencies
- 9 Leave in-channel resp
- 9 MORE (Go to Page 1 of the CATV Menu)

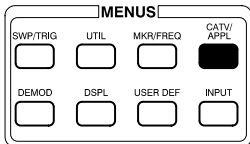

⁷ Not displayed if in Interactive mode

CATV Menu (2715 Only)

(Page 1)

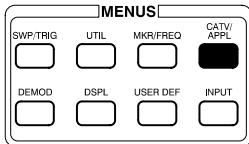

- 0 RECENTER CHANNEL xx¹
- 1 CARRIER LEVEL -- AVG POWER
 - 0 Run levels -power
 - 1 Store current results
 - 2 Display results
 - 3 Print current results (RS-232 only)
 - 4 Print stored results (RS-232 only)
 - 5 Set up carrier levels
 - 0 Accurate frequency and ampl
 - 1 Accurate amplitude only
 - 2 Fast amplitude only
 - 6 External atten/amp
 - 0 On/off
 - 1 Atten/ampl entry
 - 9 Leave carrier level -- avg pwr
- 2 CARRIER SURVEY
 - 0 Run carrier survey
 - 1 Store current results
 - 2 Display results
 - 3 Print current results (RS-232 only)
 - 4 Print stored results (RS-232 only)
 - 5 Set up carrier survey
 - 0 Accurate frequency and ampl
 - 1 Accurate amplitude only
 - 2 Fast amplitude only
 - 6 External atten/amp
 - 0 On/off
 - 1 Atten/ampl entry
 - 9 Leave carrier survey

¹ Active Channel Number

CATV Menu (2715 Only) (Continued)

(Page 1 Continued)

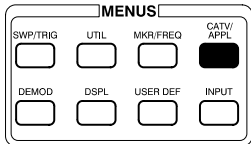

- 3 MODULATION DEPTH
 - 0 Run modulation depth
 - 1 Store current results
 - 2 Display results
 - 3 Print current results (RS-232 only)
 - 4 Print stored results (RS-232 only)
 - 5 Set up adjustment mode
 - 0 View modulation mode
 - 1 Target line
 - 2 Cycle delay
 - 3 Target line duration
 - 6 Enter adjustment mode
 - 9 Leave modulation depth
- 4 AURAL (FM) DEVIATION
 - 0 Run FM deviation
 - 1 Store current results
 - 2 Display results
 - 3 Print current results (RS-232 only)
 - 4 Print stored results (RS-232 only)
 - 5 Set up aural (FM) deviation
 - 0 Interactive
 - 1 Auto
 - 5 Measurement time
 - 6 Enter adjustment mode
 - 9 Leave aural (FM) deviation

CATV Menu (2715 Only) (Continued)

(Page 1 Continued)

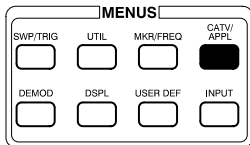

- 5 CARR/NOISE -- DESIRED/UNDESIRED
 - 0 Run C/N -- D/U
 - 1 Store current results
 - 2 Display results
 - 3 Print current results (RS-232 only)
 - 4 Print stored results (RS-232 only)
 - 5 Set up carrier/noise
 - 0 Interactive
 - 1 Auto
 - 2 Auto (Pause for carrier off)²
 - 7 In-service
 - 9 Leave C/N -- D/U
- 6 HUM/LFD
 - 0 Run hum/LFD
 - 1 Store current results
 - 2 Display results
 - 3 Print current results (RS-232 only)
 - 4 Print stored results (RS-232 only)
 - 5 Power line freq
 - 9 Leave hum/LFD
- 7 FREQUENCY RESPONSE
 - 0 Run freq resp
 - 5 Set up freq resp
 - 0 No ref
 - 1 With ref
 - 2 Start frequency
 - 3 Stop frequency
 - 4 Use default start/stop
 - 5 Acquire new reference³
 - 6 Stored reference menu³
 - 7 Edit current reference name³
 - 9 Leave frequency response

² Not displayed if IN-SERVICE is on

³ Displayed only if WITH REF is selected

CATV Menu (2715 Only) (Continued)

(Page 1 Continued)

8 CATV MEASUREMENT SETUP

0 Exit CATV measurement
mode

1 Channel table

0 STD

1 HRC

2 IRC

3-9 User defined tables

2 Skip channel

3 All channels

4 Site

5 Operator

6 Ref level unit

7 Edit Channel Table⁴

8 Remove all stored results

9 Leave CATV measurements setup

9 MORE (Go to Page 2 of the CATV Menu)

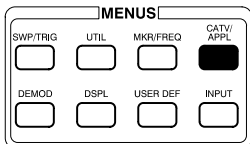

⁴ Option 50 and Option 75 only

CATV Menu (2715 Only) (Continued)

(Page 2)

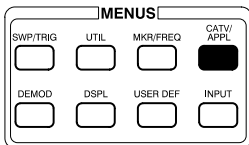

0 ADJACENT CHANNEL LEAKAGE

0 Run adjacent channel leakage

1 Store current results

2 Display results

3 Print current results (RS-232 only)

4 Print stored results (RS-232 only)

5 Measure side

9 Leave ACL

1 VIEW MODULATION (FIELD)

2 VIEW MODULATION (LINE)

3 VIEW PICTURE

4 LISTEN

5 CTB

0 Run CTB

1 Store current results

2 Display results

3 Print current results (RS-232 only)

4 Print stored results (RS-232 only)

5 Set up CTB

0 Interactive

1 Auto

2 Auto (pause for carrier off)

3 Single sweep

5 Set up Test Frequencies

0-4 User-Defined Test Frequencies

5 Use Default Test Frequencies

6 Digital/analog

9 Leave CTB

CATV Menu (2715 Only) (Continued)

(Page 2 Continued)

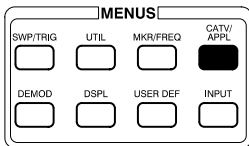

6 CSO

0 Run CSO

1 Store current results

2 Display results

3 Print current results

(RS-232 only)

4 Print stored results (RS-232 only)

5 Set up CSO

0 Interactive

1 Auto

2 Auto (pause for carrier off)⁵

3 Single sweep⁵

4 Continuous⁵

5 Set Up Test Frequencies⁶

0-4 User-Defined Test Frequencies

5 Use Default Test Frequencies

6 Carrier Frequency⁷

7 Test Interval⁷

8 Normalization Interval⁷

6 Digital/analog

7 In-Service

9 Leave CSO

7 CROSS MODULATION

0 Run cross modulation

1 Store current results

2 Display results

3 Print current results (RS-232 only)

4 Print stored results (RS-232 only)

5 Method (Frequency Domain or Time Domain (NCTA))

9 Leave cross modulation

⁵ Not displayed if In-Service is on

⁶ Not displayed if in Interactive mode

⁷ Displayed only if in Continuous mode

CATV Menu (2715 Only) (Continued)

(Page 2 Continued)

8 IN-CHANNEL RESPONSE

- 0 Run in-chan resp
- 1 Store current results
- 2 Display results
- 3 Print current results
(RS-232 only)
- 4 Print stored results (RS-232 only)
- 5 Set up In-chan resp
 - 0 Interactive
 - 1 Auto (pause for signal on)⁸
 - 2-7 user-defined test frequencies⁹
 - 8 Use default test frequencies
- 6 Test signal line number¹⁰
- 7 In-Service
- 9 Leave in-channel resp
- 9 MORE (Go to Page 1 of the CATV Menu)

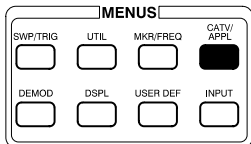

⁸ Auto if In-Service is on; otherwise Auto (Pause)

⁹ Not displayed if in Interactive mode

¹⁰ Displayed only if In-Service is on

APPL Menu

- 0 BANDWIDTH MODE
- 1 CARRIER TO NOISE
- 2 NOISE NORM'D
- 3 SIGNALSEARCH MENU
- 4 OCCUPIED BW
- 7 FM DEVIATION MODE
- 8 CATV MEASUREMENT MODE
- 9 SETUP TABLE
 - 0 db down for BW mode
 - 1 Norm BW for c/n
 - 2 Noise norm'd BW
 - 3 Percent occupied BW

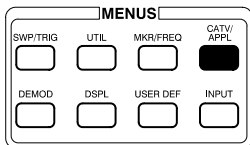

DEMOD Menu

- 0 OFF
- 1 AM DEMODULATOR
- 2 FM DEMODULATOR
- 3 BROADCAST
(AM) VIDEO/
SATELLITE (FM) VIDEO SELECTION
- 9 VIDEO MONITOR SETUP
 - 0 Video detect mode
 - 1 Sync polarity
 - 2 Video polarity

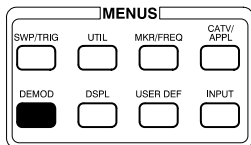

DSPL Menu

0 DIGITAL/ANALOG

1 ENSEMBLE AVERAGING

1 Initiate averaging

2 Terminate averaging

3, 4, 5, 6 Max, Mean, Min,
and Max/Min

7 Number of averages

8 Save results in display (A, B, C)

2 B, C MINUS A

3 B, C MINUS A OFFSET TO (Center or Top)

4 ACQUISITION MODE (Peak or Max/Min)

5 TITLE MODE

6 GRATICULE ILLUMINATION

7 DISPLAY SOURCE ((AM) Internal or External)

8 DISPLAY LINE

1 On/off

2 Value entry

3 Display line to marker

4 Limit detector

9 MIN HOLD

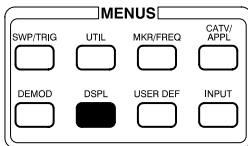

USER DEF Menu

0-8 USER DEFINED

PROGRAMS

9 USER DEF

PROG UTILITIES

0 Acquire key strokes

1 Title edit

2 Wait for end of sweep

3 Display message

4 Pause for "USER DEF" key

5 Continuous execution

6 Store

7 Delete

8 Protect

9 Time delay setup

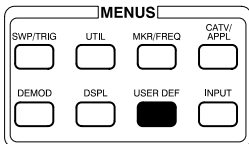

INPUT Menu

1 PREAMP

3 REF LEVEL UNIT

(dBm¹⁴, dBmV, dBV¹¹,
dBmV, dBmW¹¹, or
dBmV/meter¹¹)

4 1ST MXR INPUT LVL

(-20 dBm to -50 dBm,
-30 dBm nominal)

5 RF ATTENUATION

6 EXTERNAL ATTEN/AMPL

9 CAL SIGNAL @ 100 MHZ 18.8 dBmV

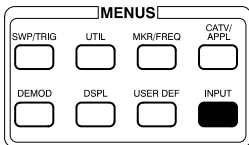

¹¹ Not available in CATV mode

Control Ranges

Frequency range: 9 kHz to 1.8 GHz¹²

Span/div range: 1 kHz to 100 MHz in a 1-2-5 sequence
and 180 MHz/div (max span) plus zero span

Ref level range: +68.8 dBmV to -21.2 dBmV

RES BW filters: 300 Hz, 1kHz, 3 kHz, 10 kHz, 30 kHz,
100 kHz, 300 kHz, 1MHz, 5 MHz 6 dB width,
 $\leq 7:1$ shape factor

RF attenuation range: 0 dB to 50 dB in 2 dB steps

Vertical scale: 10-5-1 dB per division plus linear

Video filters: 1/100 of the RES BW in AUTO mode,
or 3 Hz to 300 kHz plus WIDE in 1-3 sequence

Sweep rate: 1 msec/div to 2 sec/div
(settings ≤ 100 msec/div require an analog display)

Trigger modes: Free run, Internal, External, AC line,
TV line, and TV field

¹² Frequency Range 9 KHz to 2.15 GHz for Option 50 and Option 75